

PRIME TECT[®]

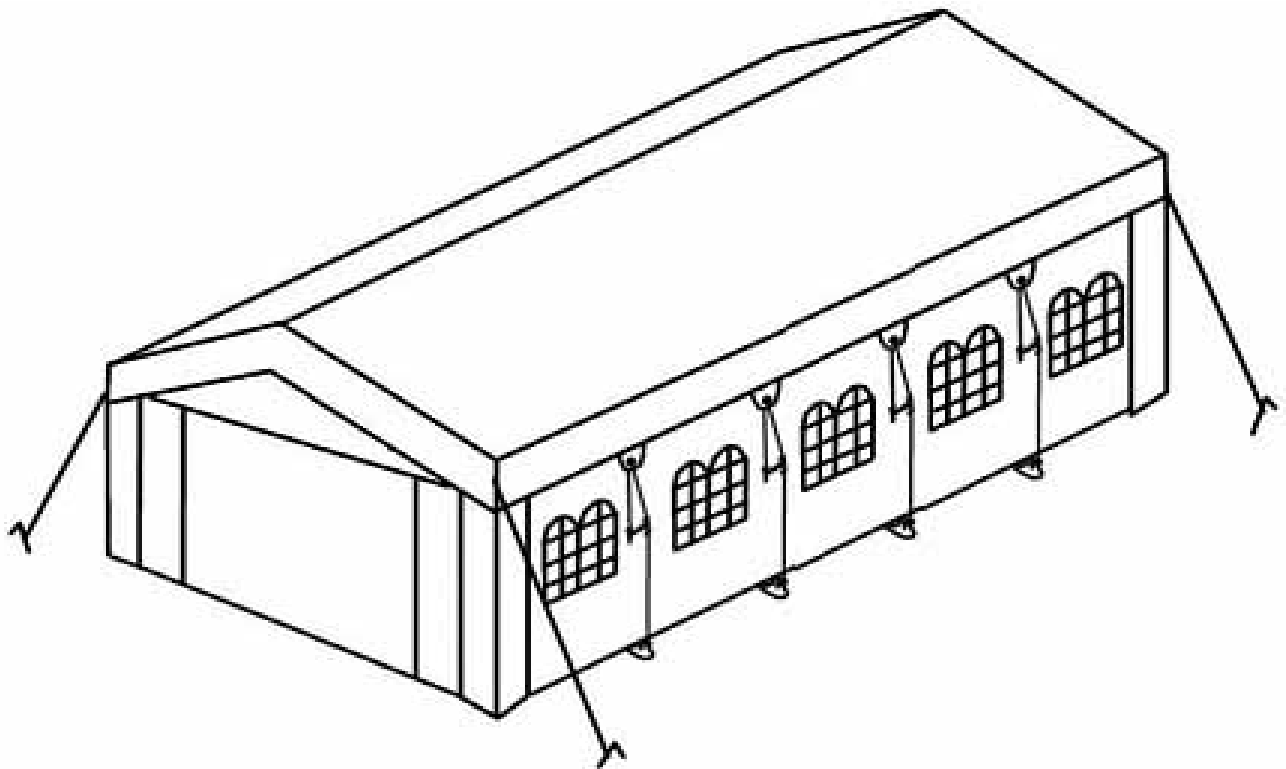

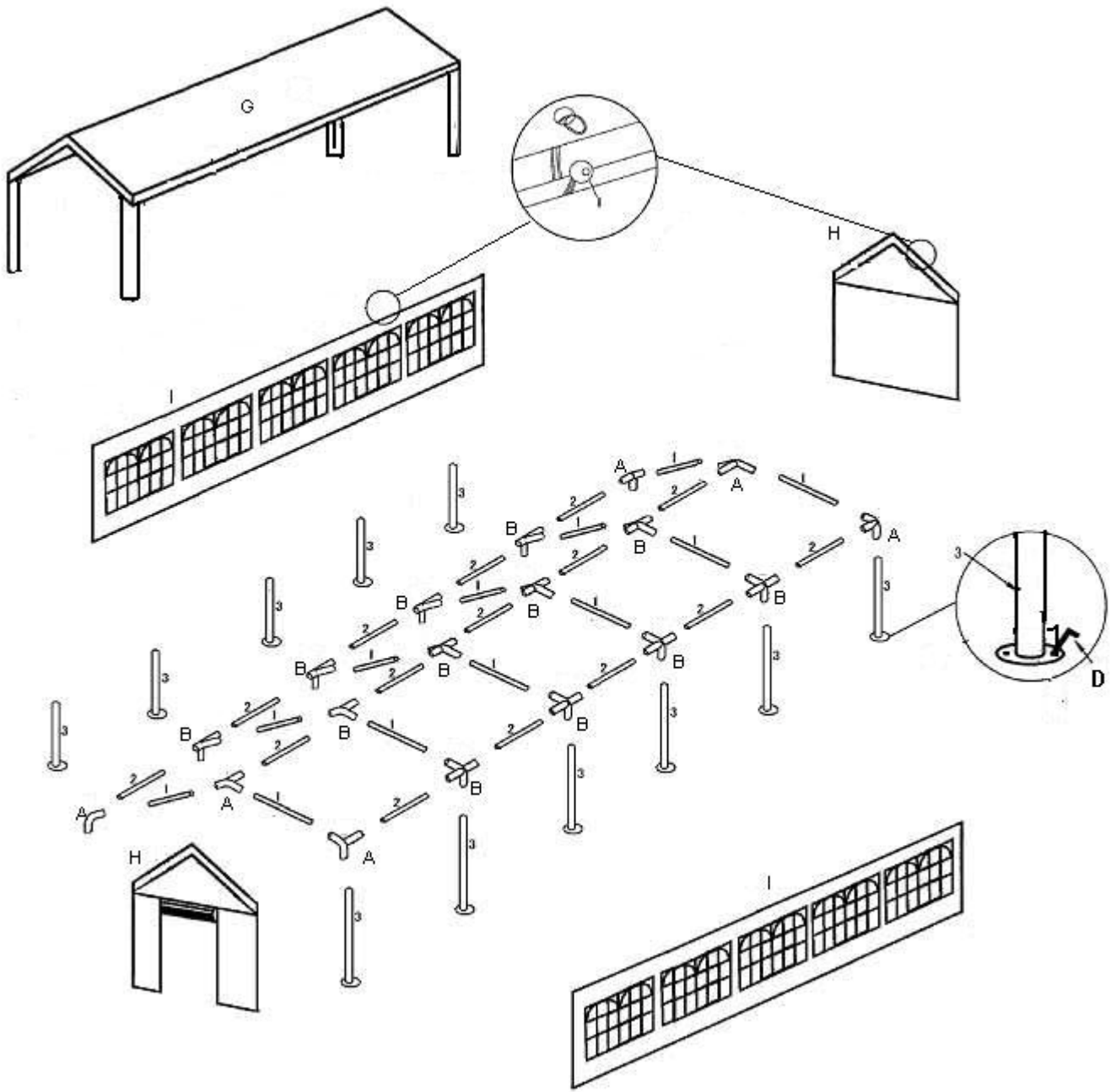







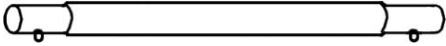
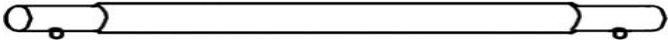
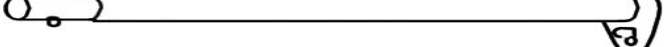

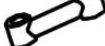

TENTS USA

CAE-100-03
Party Tent 4x10M





● Parts list

Parts no.		Description	Qty
1		Frame pole \varnothing 38mm	12
2		Frame pole \varnothing 38mm	15
3		Support pole \varnothing 38mm	12
A		3-way joint	6
B		4-way joint	12
C		Peg	14
D		Long peg	16
E		Bungee cord	92
F		tension adjuster	22
1		Adjust ropes	10
2		Adjust ropes	4
3		Adjust ropes	8
4		Guy line	4
G		Roof	1
H		End panel	2
I		Wall panel	2

● Assembly Instruction

Step 1

Select a flat ground for the tent, unpack the carton and check all the parts including tubes, tent and accessories... etc. are present as same as list.

Assemble three portions, there are separate units of (2,A,B) to construct each portion.

Assemble the framework of rooftop by joining the portion (A,B) together with poles (1).

To ensure the snap button flipped on every pole insertion for properly fitting.

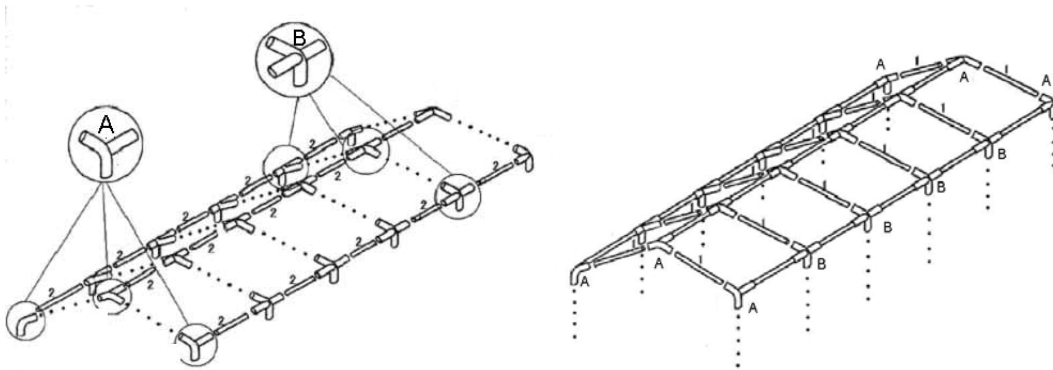

Step 2

Attach one end of supported pole (3) to the joints of portion (A).

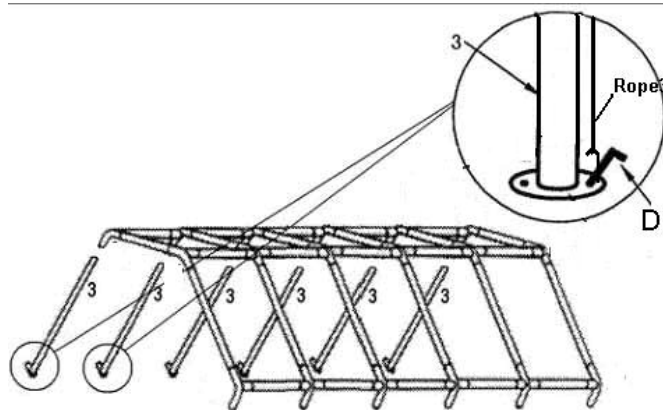

Step 3

Flatten tent roof (G) flat on top of framework, between the roof and framework, inserting the 4 adjusting ropes (2) paralleled with the ridge and 10 adjusting ropes (1) across ridge, until ends through the grommets that are constructed inside the roof and then attach to tension adjusters (F).

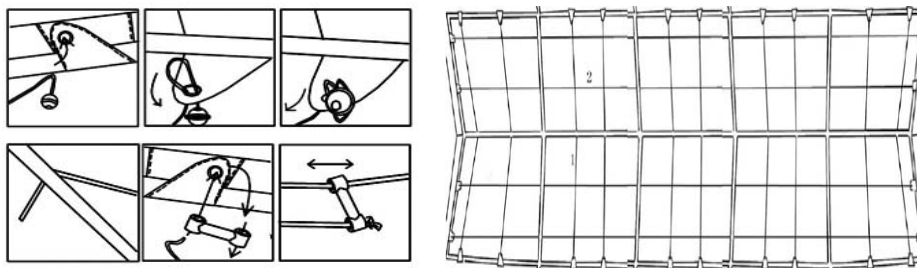

Step 4

Attach the another 4 supported poles (3) the joints of portion (A,B), built-up the framework, spread the wall panel (I) and door panel (H) attach to framework by using the bungee cords (E) clasping the frame to grommets that is constructed over the wall panel and door panel to ensure stability.

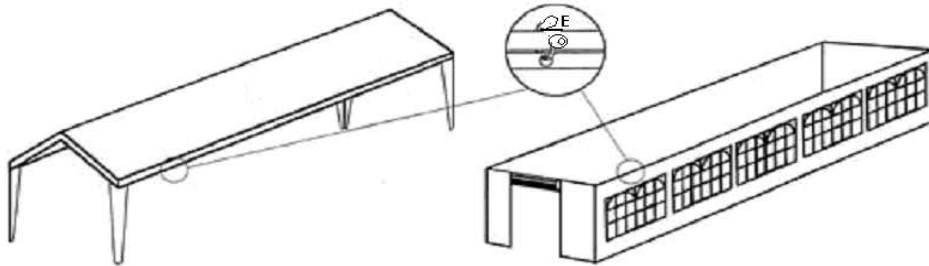

Step 5

Securing each side of the roof by 4 adjusting ropes (3), to fasten one end of rope (3) on ground stake of the two poles in between two side wall, another end of rope attach to tension adjuster (F) and grommet that are constructed on flap outside the border of roof, as shown on diagram.

To clasp the guy lines (4) to each corner of roof and another end of line fixing to ground by long peg (D).

To fix the stake on the ground by using long peg (D), then fixing the bottom of door and side-wall panel using peg (C), as shown on diagram.

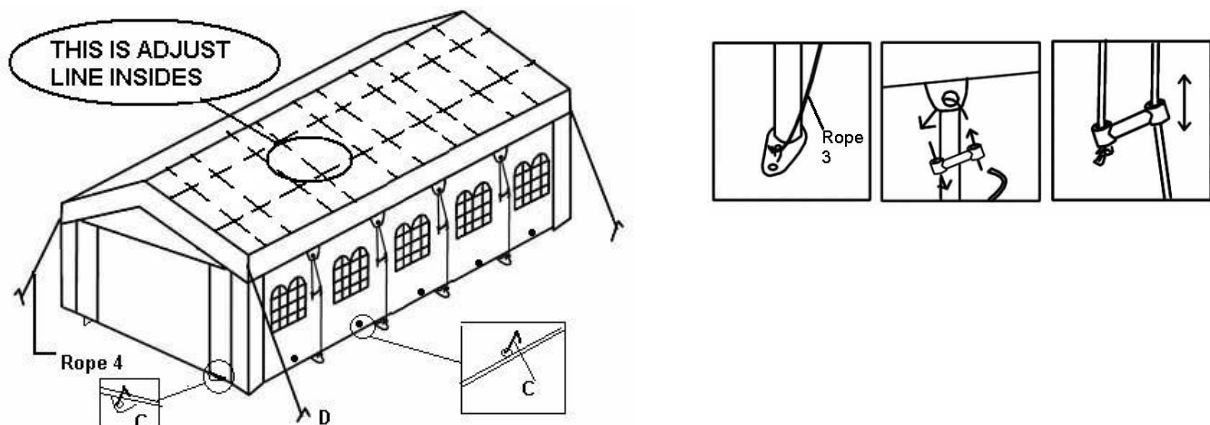

Warning

1. Take note that the tent needs to be handled carefully to avoid damage.
2. Do not force the frame as they may be damage in the process.
3. Tents are meant as temporary shelter and must be evacuated under extreme weather conditions.
4. Please select a suitable site for the tent to avoid the damage to underground sprinkler systems, water, gas or electrical lines.

PRIME TECH[®]
TENTS USA